

SCI100VC Vacuum controller

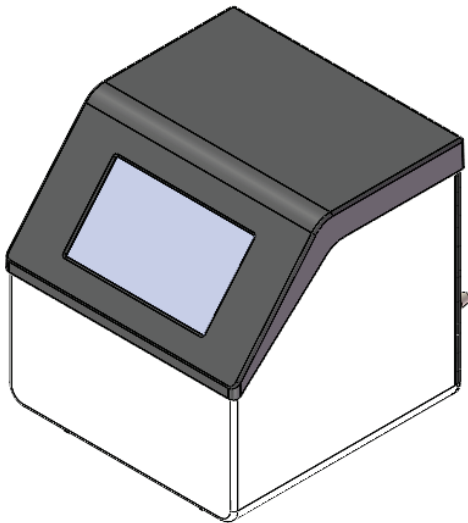

Operating Instructions

Please read the safety instructions in this manual carefully before using this product and ensure to operate this product as per the operating instructions only.

Disclaimer

- This manual had been prepared with the attitude of being responsible for the users but cannot guarantee that the contents of the manual are fully correct.
- If any occasional or subsequent loss is caused by the use of the manual, the company will not be liable in any way.
- The manual is a pure technical document, free of any implication or oblique hint of any third party. Moreover, we won't be liable for any user's misunderstanding upon the printing error(s).
- The company and any of our employees will not bare any liability for direct/indirect loss of information or business (if any) caused by the information of the manual or the product it mentioned.
- The company reserves the right to change specification and price of the product without prior intimation.
- The contents of this manual should not be copied/abstracted or modified in any form without written approval of the company.
- The manual and any content of it must not be copied, abstracted or modified in any form without the company's written approval in advance.

Table of Contents

1. SAFETY PRECAUTIONS.....	1
2. PRODUCT OVERVIEW	1
2.1 SCOPE OF APPLICATION.....	2
2.2 TECHNICAL PARAMETERS	2
2.3 COMPONENTS	3
3. OPERATING INSTRUCTIONS	4
3.1 OPEN-PACKAGE INSPECTION	4
3.2 OPERATION.....	5
4. MAINTENANCE.....	12
5. FAILURE DIAGNOSIS.....	13
6. PRODUCT CERTIFICATION.....	13
7. WARRANTY POLICY	14

1. Safety Precautions

Caution!



- Please carefully read the manual before operating the product, and observe the specifications on safe operation.
- Ensure that only trained staff operates this product.

Ground protection for safety!



- Ensure that the power socket has been properly grounded before operating the product

- Ensure that the label indicated the correct voltage before connecting the device to power supply.
- Ensure good working environment free of explosive, hazardous and inflammable substances. This product is intended for indoor use only.
- The instrument should be placed in a low humidity, well ventilated, less dust, water free environment without the perpendicular incidence of sunshine and intense light source. The environment should be free of corrosive gases or strong magnetic interference, and far away from heating gas, fire and all other heat sources.
- Ensure that the instrument and its accessories are free of any potential defects.
- Ensure that the instrument is secured tightly and standard accessories supplied by the manufacturers only should be used.
- Wear proper protective equipment while operating this instrument to prevent the potential dangerous circumstances with the risk of splashing/ release of toxic or inflammable gases.
- The power cable must be kept away from the surface of heating module rather than shield the device.
- Please prevent water from splashing on the electrical elements of the product.
- The power supply is fully disconnected only if the power plug is pulled out.
- Before assembly, disassembly, cleaning or maintenance, the main power plug must be pulled out.
- Ensure the vacuum pump's power is not more than the maximum power output by the instrument.

2. Product overview

2.1 Scope of application

- The product is intended to control the vacuum level of the vacuum system with the gas as medium in the environments like school, laboratory and factory. An environment where the product works should meet the following requirements.
- Ensure that the voltage fluctuation does not exceed normal value by $\pm 10\%$.
- Ensure to place the instrument at 30cm away from the wall and atleast 10cms away from any other instruments.
- The product is not intended for use in residential areas.

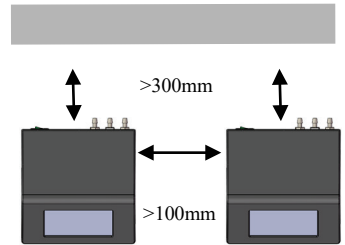

Fig. 2.1

2.2 Technical parameters

Setting range of vacuum	1-1000mbar
Determination range of vacuum degree	1-1000mbar
Control operation mode	Single-point control operation mode, program operation mode
Control program	Can save up to 5 programs. Each program contains five-step control (vacuum degree and timing can be set).
Setting mode	Touch screen setting
Display screen	5-inch TFT
Sensor overload pressure	1500mbar
Connecting tube interface diameter	6.2mm
Materials in contact with steam	PTFE, PP, silica gel and ceramics

Steam temperature	5°C-40°C
External dimension WxDxH	189mm×207mm×193mm
Weight	4.0kg
Input power supply	AC110—240V, 50Hz/60Hz
Working temperature	10°C-40°C, ≤80%RH
Input power	600W
Maximum output power	500W (220V), 300W(110V)

2.3 Components

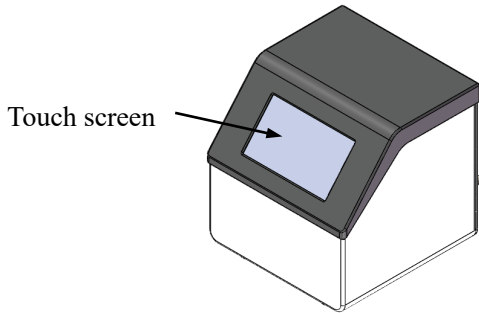

Fig. 2.3.1

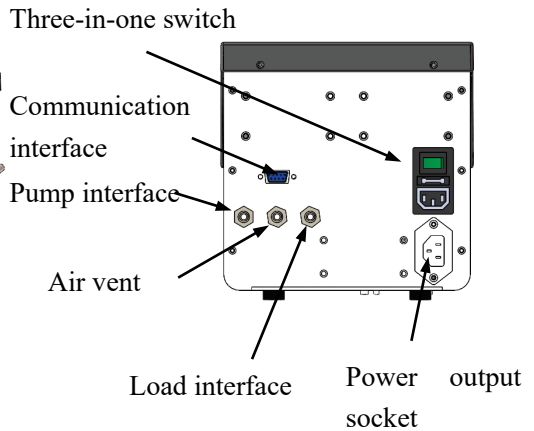

Fig. 2.3.2

Name	Description
Touch screen	Setting parameters and displaying settings and operation information
Three-in-one switch	Unit power input, with a switch controlling the power supply to the entire unit.
Communication interface	Communication
Pump interface	Connects the vacuum pump

Air vent	Connects with air or inertia gas if necessary.
Load interface	Connects the load, such as revolving evaporator.
Power output socket	Provides power supply to vacuum pump.

Table 2

3. Operating instructions

3.1 Open-package inspection

Open-package inspection aims to confirm the completeness of associated parts. The packing list is given below.

Name	Qty.
Main unit	1
Power line	1
Operating Instructions	1

Table 3

If you find any damage on the packing, please specify the damage after receipt. If you find any internal damage after unpacking, please contact your local supplier or manufacturer.



Note:

If you find any visible damage on the product, please don't connect the product to power supply.

3.2 Operation

3.2.1 Instrument preparation

- The instrument should be placed on a stable surface and well ventilated without any flammables or explosives.
- Ensure that the label indicated the correct voltage before connecting the device to power supply.
- Ensure that the power socket is grounded properly.
- Connects the lines of the instrument, vacuum pump and load properly.
- Connects the power cable of the vacuum pump to the instrument and turn ON the vacuum pump switch.
- Connect the power cable of the instrument properly, and turn ON the Power switch.

3.2.2. Startup interface description



Fig. 3.2.1

Button name	Function introduction
VENT	Gently touch VENT to vent air and lift it to stop venting.
PROGRAM	Choose the control mode and set the control pressure value and running time.
SETTINGS	Set the delay time to open and close the pump and valve, set the local atmospheric pressure, adjust the pressure sensor calibration parameters.
START	Gently touch it to start the control program, with the

	icon changed to  , gently touch it again to stop the control program.
--	--

Table 4



Note:

‘PROGRAM’ and ‘SETTINGS’ buttons cannot be operated if the control program starts.

3.2.3. Instrument configuration

Gently touch the "SETTINGS" button to pop up the password soft keyboard, enter the password (the default initial password is 6666), then press "enter" key, confirm the password is correct and then pop up the setting interface, as shown in the figure below.

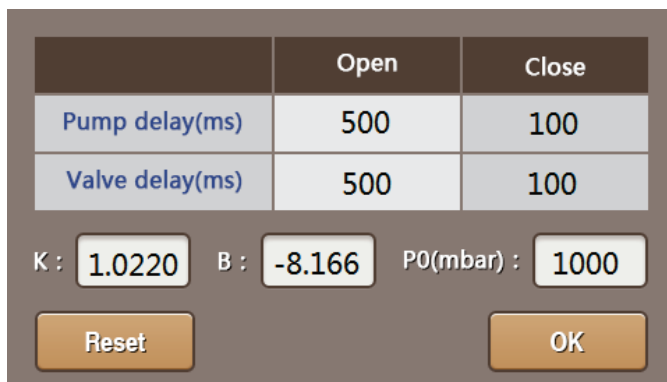

Fig. 3.2.2

Name	Function introduction
Pump Delay(ms)	The delay time after opening or closing the vacuum pump.
Valve Delay(ms)	The delay time after opening or closing the solenoid valve (inside the instrument).
K, B	Pressure sensor calibration parameters
P0(mbar)	Local atmospheric pressure value
Reset	Restore the factory settings

Table 5

After setting, click "OK" key to return to the startup interface.



Note:

Before clicking the "Reset" button, record the pressure sensor calibration parameters (K and B). After restoring the default setting, write (K and B) into the instrument, otherwise the pressure measurement accuracy will be adversely affected.

3.2.4. Operation mode selection and configuration

1. Click the “Program” button to pop up the program selection interface as shown in the following figure.

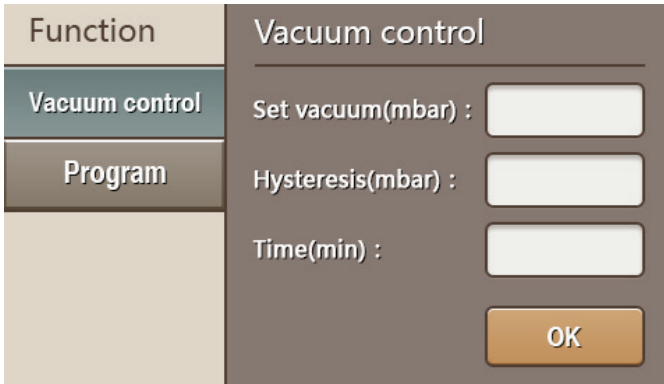

Fig. 3.2.3

Click “Vacuum control” in the “Function” section to choose the single-point control operation mode, click “Program” to select the program operation mode.

2. Single-point control operation mode

Click “Vacuum control” in the “Function” section to refresh the current page as shown in the following figure.

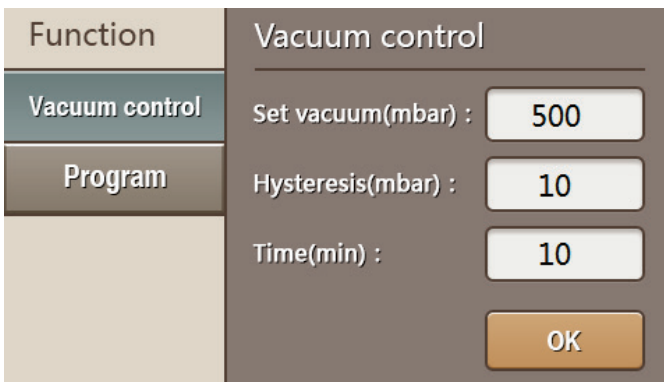

Fig. 3.2.4

Name	Function Introduction
Set vacuum(mbar)	Set the vacuum value within a range of 1 - local atmospheric pressure (P0)
Hysteresis(mbar)	Hysteresis value affects the pressure fluctuation range and the ON/OFF frequency of vacuum pump. Setting range 1-300mbar
Time(min)	Time can be set within a range of 0-5999min

Table 6

After setting the parameters, click “OK” key to return to the startup interface.



Note:

The larger the hysteresis value set, the larger the pressure fluctuation, the smaller the hysteresis value set, the smaller the pressure fluctuation and the more frequently the vacuum pump starts up and shuts down. The recommended hysteresis value is set at 10mbar.



Note:

The sum of the set vacuum value and hysteresis value cannot exceed (P0-10) mbar and the set vacuum value is larger than the hysteresis value.

3. Program operation mode

Click “Vacuum control” button in the “Function” section to pop up the program selection interface as shown in the following figure.

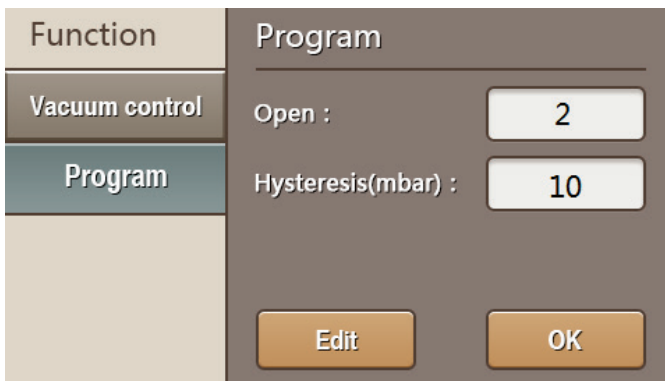

Fig. 3.2.5

(1) Program selection

Name	Function introduction
Open	Select the program number
Hysteresis(mbar)	Hysteresis value affects the pressure fluctuation range and the ON frequency of vacuum pump Setting range 1-300mbar

Table 7

After setting the parameters, click “OK” key to enter the program operation interface as shown in the following figure.



Fig. 3.2.6

(2) Program editing

Click the “Edit” button in the “program selection interface” to pop up the program editing interface as shown in the following figure.

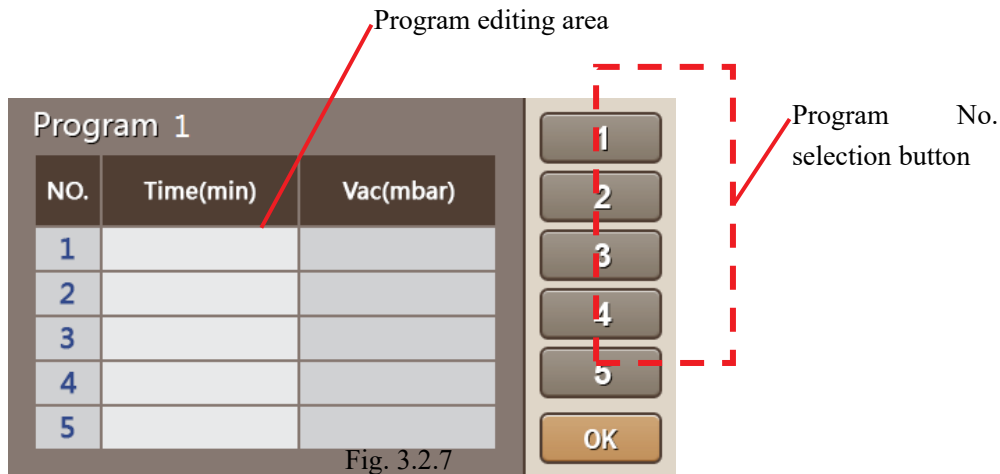

Name	Function introduction
NO	Sequence No. of program execution
Time(min)	Timing time, set within a range of 0-5999min
Vac(mbar)	Set the vacuum value within a range of 1 - local atmospheric pressure (P0)

Table 8

After setting the parameters, press the program number to be saved until the upper part of the interface indicates “save”. As shown in the figure.

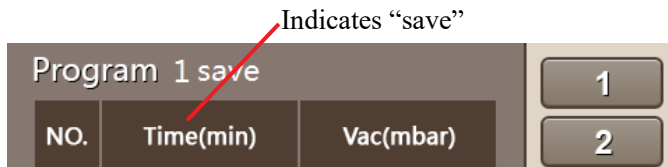

Note:

If the set vacuum value or timing is blank, it indicates that the current step

will be skipped to the next control program.

3.2.5. Ventilation

Gently touch the “VENT” button to vent air and lift it to stop venting.

4. Maintenance

Proper maintenance and operation of the instrument in good working state can extend its service life.

Keep the instrument dry and clean in routine operations. Clean the outer surface with a non-grinding cleanser and connect to power supply only if the entire surface is dry.

If liquid or moist solid enters the product, please disconnect the power supply and contact the manufacturer/ local supplier for more advice.

- Stains on the surface of device, if any, shall be cleaned by clean soft rag and detergent.
- Keep the product clean, and the cleaning solution is not allowed to flow into the machine.
- Power must be disconnected before maintenance and cleaning, and please use our recommended methods to clean the product.
- Avoid cleaning the instrument with corrosive cleaning solution.
- If this instrument is left unused for a long period, switch power OFF and store it in a dry, clean and smooth surface at normal temperature.



Caution!

Before any maintenance or inspection, the power cable must be pulled out of the socket.

Please refer to product *Service Manual* for details on machine maintenance.

5. Failure diagnosis

The advanced production technology and testing methods are used for rigorous testing before delivery, to ensure good reliability. In service, the common failures are generally caused by improper operation or setting.

If the errors cannot be handled properly, please record the error phenomenon and notify the local dealer, or contact us directly.

The following are the possible failures of the vacuum controller in application:

Fault phenomenon	Cause analysis	Solution
The vacuum pump does not work	The power switch on the vacuum pump is not turned ON. The power cable connection is improper or damaged.	Switch power ON the vacuum pump. Connect the cable properly or replace the damaged cable.
Error message appears when setting the pressure value	Check whether the set value exceeds the limit.	Adjust the set value.
The solenoid valve and pump is ON/OFF frequently.	Check the pipeline for airtightness. Check whether the hysteresis value is too small.	Connect the pipeline properly. Increase the hysteresis value.

6. Product certification

SCILOGEX certifies that the construction of this product conforms in accordance to China national and industry standards and ISO9001 standards, and other international standards organizations.

7. Warranty policy

- According to the manufacturer's warranty clause, the warranty period of the product is 24 months from the date of shipment under normal service conditions specified in the manual.
- Warranty shall not apply to any product or parts which have been damaged due to mishandling or improper installation or abnormal conditions of operation.
- This instrument is warranted to be free from defects in material and workmanship and it must be operated in accordance with our operating guidelines.
- Although great care is used when packaging items for shipment, SCILOGEX cannot accept liability for transportation of goods from SCILOGEX and transit damage is not covered by warranty

For claims under the warranty please contact your local supplier. You may also send the instrument directly to manufacturer, enclosing the invoice copy and giving reasons for the claim. Manufacturer will not be liable for freight costs.